



Residential internal doors

Timber doors in premium carpenter quality and glass doors for extra light in your home

HÖRMANN





CONTENT

4	Hörmann brand quality
6	Good reasons to try Hörmann
12	Door leaf versions
14	BaseLine <ul style="list-style-type: none">Duradecor smoothDuradecor textureLacquerReal wood veneer
20	DesignLine Concepto <ul style="list-style-type: none">Ultra mattGlossSlateLinen
28	DesignLine <ul style="list-style-type: none">StripeGrooveSteelPlainPureRail
44	ClassicLine <ul style="list-style-type: none">GeorgiaCarolinaKonturaMontanaVirginia
56	GlassLine
66	Function doors
70	Radio door lock operator SmartKey
72	Door operator PortaMatic
74	VarioFix steel frame
78	Sliding door versions
80	Glazing cut-outs / side elements / transom lights
82	Lever handles and fittings
85	Fittings for glass doors
86	Handles for sliding doors
88	Surface finishes
92	Door and frame design
94	Overview table
96	Technical data
99	Hörmann product range

Some of the doors shown are equipped with optional extras and do not always correspond to the standard models. The surface finishes and colours shown are subject to the limitations of the printing process and cannot be regarded as binding. All colours based on RAL.

All rights reserved. No part may be reproduced without our prior permission. Subject to changes.

Discover a new feeling of home: high-quality residential internal doors

Our home is the centre of our life, our safe haven, our oasis of well-being.

As a family business, this spurs us on to provide products made in Germany to give you that special feeling of being at home. Our high-quality residential internal doors contribute to this and provide your home with that extra cosy feeling.

Whether classic or modern, white lacquer or beech, with glass elements or stainless steel embellishments – Hörmann offers you the residential internal door that suits you and your furnishings perfectly.





“A good reputation must be earned.”

August Hörmann

In keeping with the tradition started by the company's founder, the Hörmann brand today is a true promise of quality. The family business has over 80 years of experience as a construction component specialist and sees itself as your partner from the very beginning of building and renovation projects. It's no surprise that Hörmann is one of Europe's most successful residential internal door providers. This makes a Hörmann residential internal door a reassuring purchase.



1 Made in Germany

All doors and frames are developed in-house by Hörmann. The doors are manufactured based on quality, environmental, energy and workplace safety management guidelines acc. to DIN EN ISO 9001, 14001, 50001 and BS OHSAS 18001 in a modern German factory. In addition, our highly qualified employees work intensively on new products, **continual further developments and improvements to details.** The results are patents and unique products on the market.



2 Brand quality for generations

We are convinced of our products and our uncompromising quality assurance. You can enjoy a Hörmann residential internal door for years to come **because you are literally choosing a “door for life”**.

3 An eye on the future

Hörmann is setting a good example. This is why the company obtains **100 % of its energy consumption from green sources**. Together with an intelligent and certified energy management system, CO₂-neutral mailing and the recycling of valuable materials, more than **40000 tons of CO₂ are saved each year**. And last but not least, Hörmann also offers products for sustainable construction.



4 Flush-fitting: Planar lever handle

For a **particularly elegant look**, equip your door with the Planar lever handle. Its **completely flush-fitting rose escutcheon**, perfectly recessed in the door leaf, certainly impresses fans of design, whilst perfect elegance is achieved by the flush-closing doors with concealed hinges. Another fine detail: The omission of the drilled keyhole means the design looks even more minimalistic and therefore more elegant.

For further information, see page 82.

5 4 × 4 concept: DesignLine Concepto

Sophisticated and versatile: The doors of **the DesignLine Concepto offer you new design options for your home**. Combine the high-quality ultra matt, gloss (high-gloss), slate and linen surface finishes with the Traffic white, Light grey, Anthracite grey and Taupe colour variants.

Read more details about the easy-to-clean and robust surface finishes from page 21.



6 Nano coating: all-glass doors

Do you want a **light-flooded home**? Then our glass doors are the perfect choice for you. Apart from its elegant appearance, the GlassLine is also particularly easy to clean: All styles with sand-blasted glazing are equipped with nano coating for fewer fingerprints.

Styles matching DesignLine Groove and Concepto

Matching all-glass doors are available for the DesignLine Groove and DesignLine Concepto styles for the perfect mix of timber and glass doors.

7 See and touch: Duradecor texture

The finely textured surfaces allow you to **feel what you see**. A wood grain texture is embossed into the door leaf, making the characteristic wood texture of the Duradecor texture surface finish palpable. This emphasises the **cosy and natural atmosphere** in your home and is also extremely easy-to-clean and durable.

For further information, see page 89.



8 Extremely impact-resistant: Duradecor surface

The high-quality surface will impress you: Duradecor features **maximum shock resistance that is 48 % better** than the average of the tested CPL surfaces from other manufacturers. It is also rocust, easy-to-clean and heat-resistant, allowing you to enjoy your door for years to come.

For further information, see page 88.



9 Permanent durability: 4Protect edge protector

Our rebated doors with angular edges and our flush-closing doors with Duradecor White lacquer, Light grey, Anthracite grey and Taupe surface finishes **are equipped as standard with the high-quality 4Protect edge protector.**

This makes your timber doors more resistant to everyday use so you can enjoy them for many years to come.

For further information, see page 13.





10 High-quality and elegant: the timber frame

Our timber frames impress with an **attractive round edge** and an **edge radius of 3 mm** **1**. The 25-mm-thick jamb lining **2** and the robust Duradecor surface finish **3** provide a **high-quality and elegant view** of your new residential internal door.

For further information, see pages 92 – 93.

11 Beautiful and robust: the steel case frame

VarioFix is the name of our steel case frame, which offers you many advantages: With the adjustable decorative rebate, it is **fitted as simply** as a timber frame. It is also **extremely durable** thanks to its high strength. In terms of design, its elegant shape impresses without visible foldback. The VarioFix steel case frame matches the timber frames, with a frame face of 55 mm perfectly **suited to timber frames**.

For further information, see pages 74 – 77.



Rebated door leaf with rounded edges

Rebated version with round edges

If you value a harmonious overall design, you can't go wrong with this version: The door leaf rests on the frame and has rounded door leaf edges for a harmonious appearance. The rebated door view with round edges is available for all timber doors, except DesignLine Stripe and ClassicLine Montana.

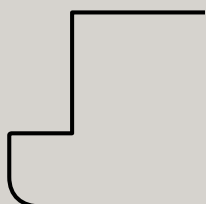

Horizontal view of door leaf



Rebated door leaf with angular edges and 4Protect edge protector

Rebated version with angular edges

If you appreciate a particularly streamlined look, then we recommend this version. The door leaf rests on the frame and has a **beautifully designed, angular edge**. It is available for all timber doors, except ClassicLine Virginia and ClassicLine Carolina. This version impresses in the Duradecor surface finishes with 4Protect edge protector and in a painted surface finish **with a perfect joint-free look**.

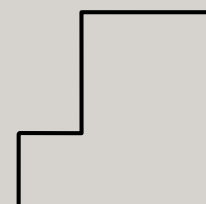

Horizontal view of door leaf



Flush-closing door leaf



Perfect joint-free look for a particularly elegant door view

Flush version

Would you like an **exclusive door view with a virtually flush-fitting transition** to the frame? Then we recommend a flush-closing door leaf, which harmonises particularly well with a modern design.

This version is available for all timber doors with the exception of ClassicLine Virginia and ClassicLine Carolina. This version impresses in the Duradecor surface finishes with 4Protect edge protector and in a painted surface finish with a **perfect joint-free look**.



Horizontal view of door leaf

4Protect edge protector

The 4-fold edge protector for **flush-closing doors and rebated doors with angular edges** in the Duradecor surface finish White lacquer, Light grey, Anthracite, Taupe, White Parchment, Light grey Parchment, White Ash and Brushed White impresses with captivating features:

1. High impact resistance
2. High wear resistance
3. High scratch resistance
4. **Perfect joint-free look**, meaning that unlike conventional doors, no visible joints disturb the high-quality appearance of the door.



Conventional door leaf with visible joint



Timelessly elegant: BaseLine timber doors

Do you value the feel-good character in your home? Then the doors from the BaseLine series are the right choice for you. The door leaf in a flush or rebated version, combined with your preferred colour or your preferred decor creates a homely atmosphere that invites you to relax.

All BaseLine timber doors are available in the high-quality surfaces Duradecor smooth, Duradecor textured, lacquer and real wood veneer. There are a variety of colours and decors available for perfect harmony with your interior design style. For even more individuality, we offer you almost every preferred colour as an HPL surface finish. Or would you like to design your residential internal doors yourself? Then choose the paintable priming film. Discover all design possibilities on the next pages.











Duradecor smooth

The extremely impact-resistant Duradecor surface finish is the right choice for your home. Whether elegant White lacquer, modern grey or cosy timber decors, whether with or without glazing cut-out – you are sure to find a residential internal door to your taste. Our flush-closing doors and rebated doors with angular edges in the Duradecor surface finish White lacquer, Light grey, White Parchment, Light grey Parchment and White Ash surface finishes are equipped with the high-quality 4Protect edge protector as standard.

Colours and designs

-  White lacquer RAL 9016
-  Light grey RAL 7035
-  White Parchment
-  Light grey Parchment
-  White Ash
-  Canadian Maple
-  French Beech

For further information, see page 88.



BaseLine











Duradecor smooth
White lacquer RAL 9016



Duradecor texture

The Duradecor texture surface stylishly unites a feeling of real wood with ease of care. It represents the natural character of timber in a subtle way: A wood grain texture is embossed into the door leaf, making the characteristic wood texture palpable. Flush-closing doors and rebated doors with angular edges in the Duradecor textured surface finish Brushed White are equipped with the high-quality 4Protect edge protector as standard.

Decors

-  Grey Oak*
-  White Oak*
-  Wild Oak*
-  Raw Oak*
-  Dark Oak
-  Spanish Oak*
-  Walnut
-  Italian Acacia
-  Brushed Salted Oak
-  Brushed Pine
-  Brushed White

* also with horizontal grains
For further information,
see page 89.

BaseLine

Duradecor texture
Brushed White



Lacquer

Timber doors with painted surfaces have an especially classic and high-quality effect. The Hörmann paint on a white Duradecor base plate ensures a uniform surface, joint-free look around the edges as well as a rich, vibrant colour.

Colours

-  Traffic white RAL 9016
-  Pure white RAL 9010
-  Light grey RAL 7035
-  Anthracite grey RAL 7016
-  RAL to choose

For further information, see page 91.

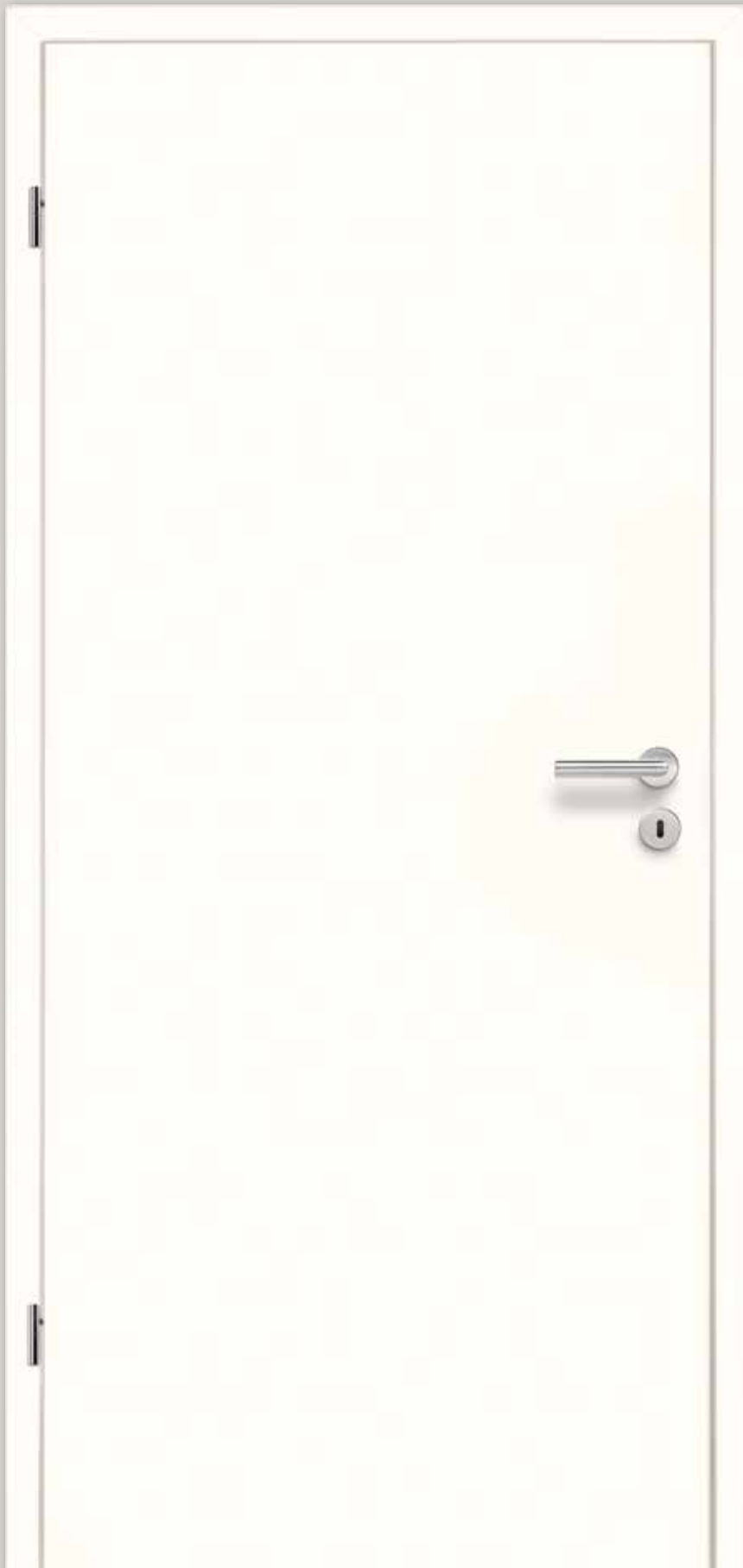

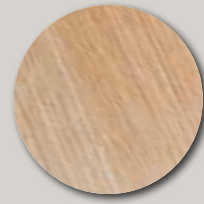















Real wood veneer

Natural, cosy, unique – Hörmann real wood veneers are produced from high-quality real timber and are truly unique.

Veneers

-  Maple*
-  Beech*
-  Ash
-  Limba
-  Paintable Limba
-  Mountain Oak
-  American Oak*
-  Knotted Oak*
-  Matt lacquer Alpine Oak
-  Oiled Oak in stressed timber
-  American Walnut*
-  Stained Oak
-  Macore
-  Mahogany

* also with horizontal grains

For further information, see page 91.

BaseLine

Real wood veneer matt lacquer
Alpine Oak



The 4 × 4 concept: DesignLine Concepto

DesignLine Concepto is the perfect choice for a modern interior design style. Four trend colours come across four elegant surfaces, allowing you to realise individual room concepts in your own home – and extremely stylishly.

Discover the large selection of combination options.

For further information, see page 90.

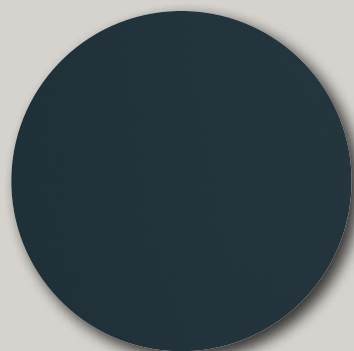





Ultra matt

The particularly elegant soft matt Duradecor surface finish meets the highest demands both visually and haptically. Ultra matt combines the high resistance to fingerprints and soiling with a previously unattainable matt finish. Doors with angular edges are equipped with the high-quality 4Protect edge protector as standard.



Colours

-  White
-  Light grey
-  Anthracite grey
-  Taupe

For further information, see page 90.

DesignLine Concepto
Ultra matt Anthracite grey





Gloss

Sparkling accents or an individual touch – with a high-gloss surface, you can do both: The crystal-look surface finish captivates with a unique brilliance. Light effects and reflections create an unmistakable ambience.



Colours

-  White
-  Light grey
-  Anthracite grey
-  Taupe

For further information, see page 90.







Slate

Experience the difference with all your senses: The extremely impact-resistant slate surface finish with a textured feel is the right choice if you prefer a modern and comfortable living design. The light-shadow contrast on the raised texture gives it a very pleasant and natural appearance. This variant is also available as a glass door.



Colours

-  White
-  Light grey
-  Anthracite grey
-  Taupe

For further information, see page 90.

DesignLine Concepto
Slate White

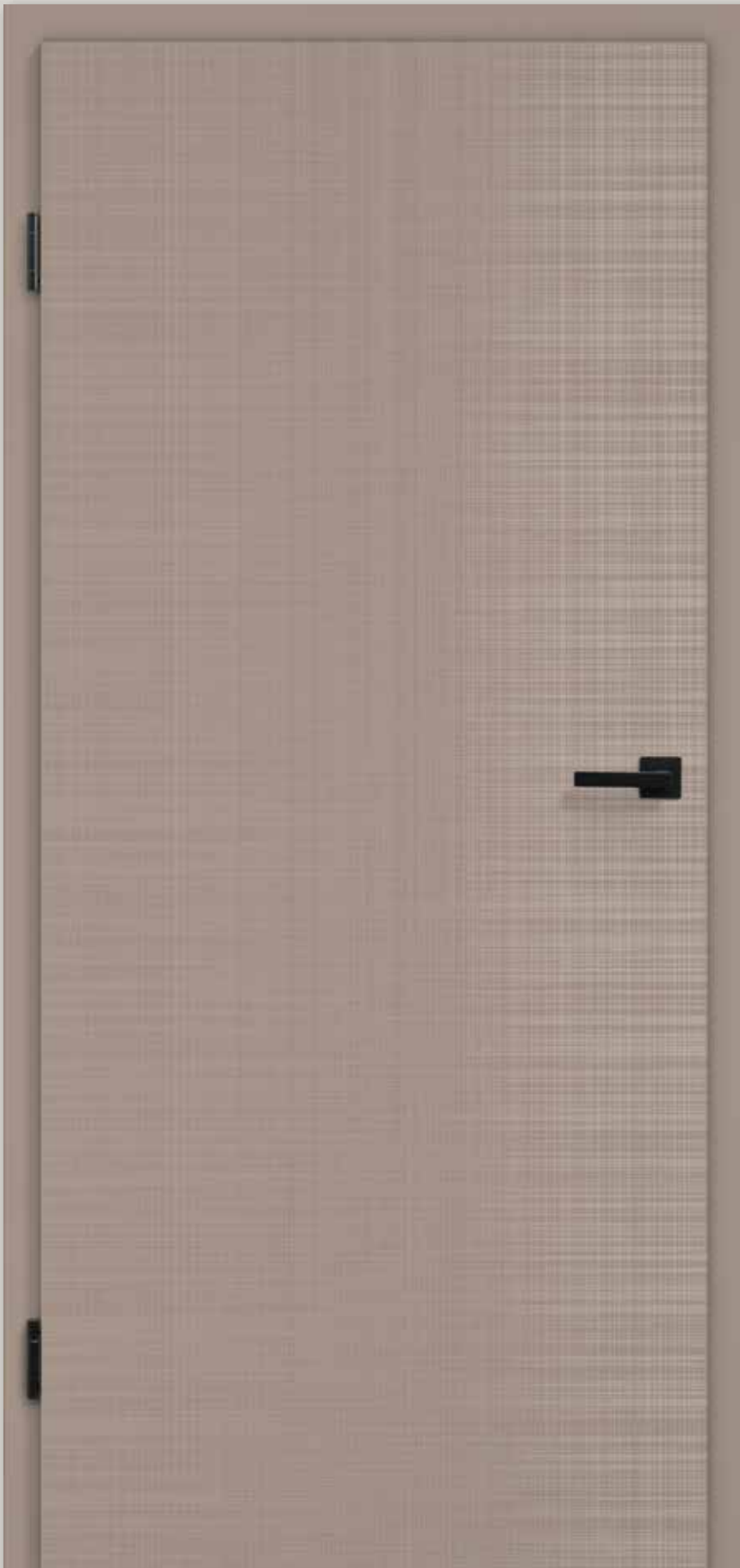

Linen

The new Duradecor surface Linen convinces with its fine, tactile texture. This design blends particularly well with wood shades and suits a sophisticated, rustic-modern decorative style. At the same time, the surface is robust and easy-to-clean. The new Linen surface finish is available to choose as a glass door.



Colours

-  White
-  Light grey
-  Anthracite grey
-  Taupe

For further information, see page 90.

DesignLine Concepto

Linen Taupe, lever handles and hinges in black.edition

For harmonious room concepts:
matching glass doors



ConceptoGlass

Single-pane safety glass, digital print
Linen White



ConceptoGlass

Single-pane safety glass, digital print
Slate Anthracite grey



ConceptoGlass
Single-pane safety glass,
digital print
Slate Taupe



ConceptoGlass
Single-pane safety glass,
digital print
Slate Light grey



ConceptoGlass
Single-pane safety glass,
digital print
Slate White

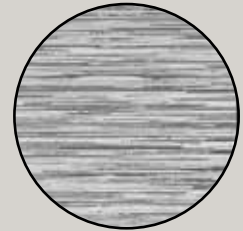

Slate texture for
a modern, cosy home
design



ConceptoGlass
Single-pane safety glass,
digital print
Light grey linen



ConceptoGlass
Single-pane safety glass,
digital print
Linen Anthracite grey



ConceptoGlass
Single-pane safety glass,
digital print
Linen Taupe

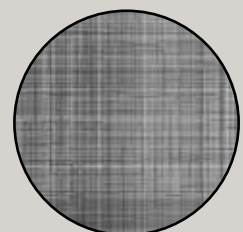

The discerning Linen
design harmonises
perfectly with the
DesignLine Concepto
Linen timber door



The door of your dreams: DesignLine

Create the door of your dreams with DesignLine. Whether style elements such as stainless steel embellishments, recessed joints or modern glass doors, whether real wood veneer or high-quality paint – the DesignLine offers a variety of door styles.

With the DesignLine residential internal doors and their different versions, discover the door that matches your home in terms of design, colour and decor.

For further information on surface finishes, colours and decors, see pages 88 – 91.





Stripe

The Stripe style with embossed grooves offers you a tasteful design with a little something extra. Flush-closing doors and rebated doors with angular edges are equipped with the high-quality 4Protect edge protector as standard.



Duradecor smooth

White lacquer RAL 9016

For further information, see page 88.

Stripe 15
Duradecor
White lacquer RAL 9016







Groove

The grooves milled into the door leaf and the high-quality paint finish make the Groove style an elegant eye-catcher.



Colours

-  Traffic white RAL 9016
-  Pure white RAL 9010
-  Light grey RAL 7035
-  Anthracite grey RAL 7016
-  RAL to choose

For further information, see page 91.

Groove 11
Lacquer
Traffic white RAL 9016



Groove 13
Lacquer
Traffic white RAL 9016



GrooveGlass 13
with matt lines



Groove 14
Lacquer
Traffic white RAL 9016



GrooveGlass 14
with matt lines



Groove 3
Lacquer
Traffic white RAL 9016



Groove 16
Lacquer
Traffic white RAL 9016



GrooveGlass 16
with clear edges



Groove 18
Lacquer
Traffic white RAL 9016



GrooveGlass 14
with clear lines



Groove 15
Lacquer
Traffic white RAL 9016



GrooveGlass 15/5
with matt lines



GrooveGlass 15/5
with clear lines



Groove 19
Lacquer
Traffic white RAL 9016



Groove 20
Lacquer
Traffic white RAL 9016



GrooveGlass 20
with matt lines



GrooveGlass 20
with clear lines



Groove 21
Lacquer
Traffic white RAL 9016



Groove 22
Lacquer
Traffic white RAL 9016



Groove 23
Lacquer
Traffic white RAL 9016



GrooveGlass 23
with matt line



Groove 29
Lacquer
Traffic white RAL 9016



GrooveGlass 29
with matt lines



GrooveGlass 29
with clear lines



GrooveGlass 29
with matt line



GrooveGlass 23
with clear line



Groove 27
Lacquer
Traffic white RAL 9016



Groove 31
Lacquer
Traffic white RAL 9016



Groove 34
Lacquer
Traffic white RAL 9016



Groove 39
Lacquer
Traffic white RAL 9016



Groove 44
Lacquer
Traffic white RAL 9016



Groove 49
Lacquer
Traffic white RAL 9016



Groove 50
Lacquer
Traffic white RAL 9016



Groove 51
Lacquer
Traffic white RAL 9016



GrooveGlass 51
with clear line



Groove 53
Lacquer
Traffic white RAL 9016



Groove 54
Lacquer
Traffic white RAL 9016



Groove 85
Lacquer
Traffic white RAL 9016



GrooveGlass 85
with clear lines



Groove 86
Lacquer
Traffic white RAL 9016



Groove 87
Lacquer
Traffic white RAL 9016



Groove 55
Lacquer
Traffic white RAL 9016



Groove 56
Lacquer
Traffic white RAL 9016



Groove 78
Lacquer
Traffic white RAL 9016



GrooveGlass 78
with clear line



Groove 88
Lacquer
Traffic white RAL 9016



Groove 89
Lacquer
Traffic white RAL 9016



Groove 92
Lacquer
Traffic white RAL 9016

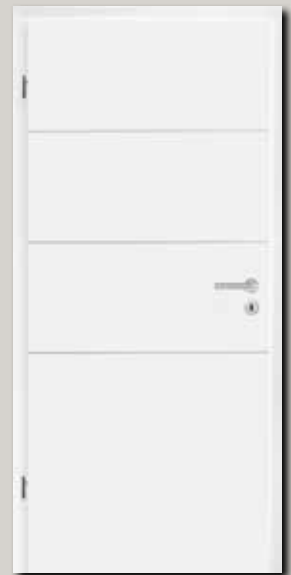

Groove 93
Lacquer
Traffic white RAL 9016



Steel

The Steel style represents a modern design thanks to the surface-mounted embellishments in a stainless steel look.



Plain

The Plain style creates elegant accents with inlaid and therefore flush-fitting embellishments in a stainless steel look.

Steel 14 / Plain 14-7
Duradecor
White lacquer RAL 9016



Steel 16
Duradecor
White lacquer RAL 9016



Steel 20
Duradecor
White lacquer RAL 9016









Steel 23 / Plain 23-7
Duradecor
White lacquer RAL 9016













Steel 27 / Plain 27-7
Duradecor
White lacquer RAL 9016



Duradecor smooth

-  White lacquer RAL 9016
-  Light grey RAL 7035
-  White Parchment
-  Light grey Parchment
-  White Ash
-  Canadian Maple
-  French Beech

Duradecor texture





-  Grey Oak*
-  White Oak*
-  Wild Oak*
-  Raw Oak*
-  Dark Oak
-  Spanish Oak*
-  Walnut
-  Italian Acacia
-  Brushed Salted Oak
-  Brushed Pine
-  Brushed White

* also with horizontal grains

Duradecor ultra matt

-  White
-  Light grey
-  Anthracite grey
-  Taupe

Lacquer

-  Traffic white RAL 9016
-  Pure white RAL 9010
-  Light grey RAL 7035
-  Anthracite grey RAL 7016
-  RAL to choose



For further information,
see from page 88.



Steel 29 / Plain 29-7
Duradecor
White lacquer RAL 9016



Steel 37 / Plain 37-7
Duradecor
White lacquer RAL 9016



Steel 38
Duradecor
White lacquer RAL 9016



Steel 39
Duradecor
White lacquer RAL 9016



Steel 44
Duradecor
White lacquer RAL 9016



Steel 78
Duradecor
White lacquer RAL 9016



Pure

With its recessed, streamlined glass element over the entire door leaf height, the Pure style is impressive in every aspect.



Pure centre
Duradecor White lacquer RAL 9016









Pure hinge side
Duradecor
White lacquer RAL 9016













Pure lock side
Duradecor
White lacquer RAL 9016



Duradecor smooth

-  White lacquer RAL 9016
-  Light grey RAL 7035
-  White Parchment
-  Light grey Parchment
-  White Ash
-  Canadian Maple
-  French Beech





Duradecor texture

-  Grey Oak*
-  White Oak*
-  Wild Oak*
-  Raw Oak*
-  Dark Oak
-  Spanish Oak*
-  Walnut
-  Italian Acacia
-  Brushed Salted Oak
-  Brushed Pine
-  Brushed White

* also with horizontal grains



Lacquer

-  Traffic white RAL 9016
-  Pure white RAL 9010
-  Light grey RAL 7035
-  Anthracite grey RAL 7016
-  RAL to choose

For further information, see from page 88.



Rail 2
Duradecor White lacquer RAL 9016,
Satinato



Rail

We recommend the timber and glass combination Rail as the perfect addition to the DesignLine timber door styles.

Glass variants



Clear glass

Available in the types of glass Clear and Clear White. For further information, see page 65.



Matt glass

Available in the types of glass Satinato and silkscreen, solid. For further information, see pages 62 and 65.







Design glass











Available in the glass styles Lines, Wave, Gropus matt, Gropus clear, Gisa, Jil, Raff, GrooveGlas 15 clear / matt, GrooveGlas 29 clear / matt. For further information, see pages 32 – 37 or 58 – 64.



Duradecor smooth

-  White lacquer RAL 9016
-  Light grey RAL 7035
-  White Parchment
-  Light grey Parchment
-  White Ash
-  Canadian Maple
-  French Beech





Duradecor texture

-  Grey Oak*
-  White Oak*
-  Wild Oak*
-  Raw Oak*
-  Dark Oak
-  Spanish Oak*
-  Walnut
-  Italian Acacia
-  Brushed Salted Oak
-  Brushed Pine
-  Brushed White

* also with horizontal grains



Lacquer

-  Traffic white RAL 9016
-  Pure white RAL 9010
-  Light grey RAL 7035
-  Anthracite grey RAL 7016
-  RAL to choose



Rail 1

Duradecor White lacquer RAL 9016,
GrooveGlas 15 with clear lines

For further information,
see from page 88.



For fans of a classic and elegant style: ClassicLine

Do you want a classic look that's also modern? Then our timeless ClassicLine styles are the perfect choice for you. Discover your favourite door for the perfect country house style.

All styles from this series impress with handcrafted details in excellent quality: The particularly high-quality doors Georgia with their inlaid profile strip. The Carolina styles with embossed profiling, the new Montana styles with high-quality reconditioned frames, the new Kontura styles with contour-milled profiles and the Virginia panel doors with their elegant design.

The same applies to the ClassicLine: Depending on the door version, you can choose between the Duradecor smooth and the Duradecor textured, lacquer or decor finishes as well as many colours and decors.

For further information, see pages 88 – 91.





Georgia 1
Duradecor White lacquer RAL 9016





Georgia









The high-quality profile strip for the Georgia door style is inlaid into grooves in the door leaf using traditional carpentry techniques, lending these styles an elegant appearance.



Duradecor smooth

-  White lacquer RAL 9016
-  White Ash

Duradecor texture

-  Grey Oak*
-  White Oak*
-  Wild Oak*
-  Raw Oak*
-  Dark Oak
-  Italian Acacia
-  Brushed Salted Oak
-  Brushed Pine

* also with horizontal grains



Lacquer

-  Traffic white RAL 9016

For further information, see from page 88.



Georgia 2
Duradecor
White lacquer RAL 9016



Georgia 2
with glazing cut-out
Duradecor
White lacquer RAL 9016



Georgia 3
Duradecor
White lacquer RAL 9016



Georgia 3
with glazing cut-out
Duradecor
White lacquer RAL 9016



Georgia 4
Duradecor
White lacquer RAL 9016



Georgia 4
with glazing cut-out
Duradecor
White lacquer RAL 9016



Georgia 5
Duradecor
White lacquer RAL 9016



Georgia 5
with glazing cut-out
Duradecor
White lacquer RAL 9016



Carolina

The panel frames of the Carolina door styles are created through an embossed profile in the door leaf. The high-quality paint coating means you can enjoy a smooth, brilliant colour surface.



Lacquer

 Traffic white RAL 9016

For further information, see page 91.

Carolina 5

Lacquer
Traffic white RAL 9016



Carolina 1
Lacquer
Traffic white RAL 9016



Carolina 1
with glazing cut-out LA
rail 2 / 3
Lacquer
Traffic white RAL 9016



Carolina 1
with glazing cut-out
Lugano
Lacquer
Traffic white RAL 9016



Carolina 2
Lacquer
Traffic white RAL 9016



Carolina 2
with glazing cut-out LA 1
Lacquer
Traffic white RAL 9016



Carolina 4
Lacquer
Traffic white RAL 9016



Carolina 4
with glazing cut-out LA
rail 2 / 3
Lacquer
Traffic white RAL 9016



Carolina 5
with glazing cut-out LA 3
Lacquer
Traffic white RAL 9016







Kontura

The Kontura series door styles are particularly charming thanks to their contour-milled profiles in combination with a slight V-groove.



Lacquer

-  Traffic white RAL 9016
-  Pure white RAL 9010
-  Light grey RAL 7035
-  Anthracite grey RAL 7016
-  RAL to choose

For further information, see page 91.

Kontura 2

Lacquer
Traffic white RAL 9016



Kontura 1
with glazing cut-out LA 2 1
Lacquer
Traffic white RAL 9016



Kontura 3
with glazing cut-out LA
Lacquer
Traffic white RAL 9016



Kontura 4
Rail 1/3
Lacquer
Traffic white RAL 9016



Kontura 5
Lacquer
Traffic white RAL 9016



Kontura 6
with glazing cut-out LA 2
Lacquer
Traffic white RAL 9016



Kontura 7
Lacquer
Traffic white RAL 9016



Kontura 12
Lacquer
Traffic white RAL 9016



Kontura 12
with glazing cut-out LA
Lacquer
Traffic white RAL 9016



Montana

High-quality frames emphasise the simple elegance of the Montana style series. The reduced design language matches both a classic and modern interior style.



Lacquer

 Traffic white RAL 9016

For further information,
see page 91.

Montana 4
with glazing cut-out
Lacquer
Traffic white RAL 9016



Montana 1
with glazing cut-out
Lacquer
Traffic white RAL 9016



Montana 2
Lacquer
Traffic white RAL 9016



Montana 3
Lacquer
Traffic white RAL 9016



Montana 5
Lacquer
Traffic white RAL 9016



Montana 6
with glazing cut-out
Lacquer
Traffic white RAL 9016



Montana 7
Lacquer
Traffic white RAL 9016



Montana 7
with glazing cut-out
Lacquer
Traffic white RAL 9016



Montana 8
Lacquer
Traffic white RAL 9016



Virginia

This classic door version, also called a panel door, consists of a frame construction with up to 2 friezes. The sections can be filled either with a glazing or a timber board.

Decor

 White lacquer similar to RAL 9016

Virginia 3

White lacquer decor with 3 glazing sections



Virginia 1
White lacquer decor



Virginia 1
White lacquer decor
with 1 glazing section



Virginia 2
White lacquer decor



Virginia 2
White lacquer decor
with 1 glazing section



Virginia 2
White lacquer decor
with 2 glazing sections



Virginia 3
White lacquer decor



Virginia 3
White lacquer decor
with 1 glazing section



Virginia 3
White lacquer decor
with 2 glazing sections



More light for your home: GlassLine

GlassLine doors offer you many clear advantages: Glass doors are upmarket and chic, contributing an open design for your home and lending each room a particular charm.

Discover the design that best suits your home and choose between hinged doors, glass doors with timber frames or sliding doors.

Special and very individual accentuation is set with the new tinted styles, which give your glass door a striking colour nuance.



Aldo
Single-pane safety glass,
sand-blasted,
with clear stripes



Amra
Single-pane safety glass,
sand-blasted,
with matt stripes



Bamante
Single-pane safety glass,
sand-blasted, with clear
sections and matt stripes



City
Single-pane safety glass,
sand-blasted, with matt
sections



Graphic
Single-pane safety glass,
sand-blasted,
with matt stripes



Graphic
Single-pane safety glass,
sand-blasted,
with clear stripes



Jada
Single-pane safety glass,
sand-blasted, with clear
and matt stripes



Jil
Single-pane safety glass,
sand-blasted,
with matt stripes



Corbus
Single-pane safety glass,
sand-blasted, with matt
rectangles



Corbus
Single-pane safety glass,
sand-blasted, with clear
rectangles



Cube
Single-pane safety glass,
sand-blasted, with matt
sections



Sand-blasting

If you value individuality:
The sandblasting technique
draws delicate designs in the
glass surface. The matt
surface finish with nano
coating guarantees fewer
fingerprints.



Jil
Single-pane safety glass,
sand-blasted,
with clear stripes



Liko
Single-pane safety glass,
sand-blasted,
with matt stripes



Liko
Single-pane safety glass,
sand-blasted,
with clear stripes



Lilu
Single-pane safety glass,
sand-blasted,
with matt stripes



Luba
Single-pane safety glass,
sand-blasted,
with matt stripes



Meda
Single-pane safety glass,
sand-blasted,
with clear stripes



Memory
Single-pane safety glass,
sand-blasted,
with clear squares



Memory
Single-pane safety glass,
sand-blasted,
with matt squares



Milton
Single-pane safety glass,
sand-blasted,
with matt stripes



Milton
Single-pane safety glass,
sand-blasted,
with clear stripes



Nubia
Single-pane safety glass,
sand-blasted, matt
surfaces blend into
clear surfaces



Pinta
Single-pane safety glass,
sand-blasted,
with matt sections



Privat

Single-pane safety glass, sand-blasted, style to choose, shown: with clear text



Raff

Single-pane safety glass, sand-blasted, with clear style



Raff

Single-pane safety glass, sand-blasted, with matt style (optionally in silkscreen)



Saha

Single-pane safety glass, sand-blasted, with matt stripes



Wave

Single-pane safety glass, sand-blasted, with clear style (optionally in silkscreen)



Wave

Single-pane safety glass, sand-blasted, with matt style



Wildlife

Single-pane safety glass, sand-blasted, with matt stripes



Wildlife

Single-pane safety glass, sand-blasted, with clear stripes



Silkscreen

Design meets the highest quality surface embellishment: The particularly scratch-resistant surface is easy to clean and resistant to soiling.



Batista

Single-pane safety glass, silkscreen, with matt and clear stripes



Lou

Single-pane safety glass, silkscreen, with matt circles



Rika

Single-pane safety glass, silkscreen, with matt rectangles



Solid silkscreen

Single-pane safety glass, silkscreen, solid matt



Yoko

Single-pane safety glass, silkscreen, with clear stripes



Fluted glass

The fluted glass on the glass door is created by a fine V-groove. A clear or satin-finished glass is used depending on the preferred opaqueness. The fluted glass convinces with special patterns, its tactile feel and the extraordinary play of light produced by the prism effect.



Coco
Single-pane safety glass,
Satinato with fluted glass



Gropus
Single-pane safety glass,
Satinato with fluted glass



Velita
Single-pane safety glass,
clear with fluted glass



Coco
Single-pane safety glass,
clear with fluted glass



Gropus
Single-pane safety glass,
clear with fluted glass



Velita
Single-pane safety glass,
Satinato with fluted glass



Laser technique

This glass finish offers fine details and shading. The depth effect creates fascinating effects, which are further enhanced by the brilliance of the glass door.



Agesa

Single-pane safety glass, laser technique, with matt stripes



Aino

Single-pane safety glass, laser technique, with matt stripes

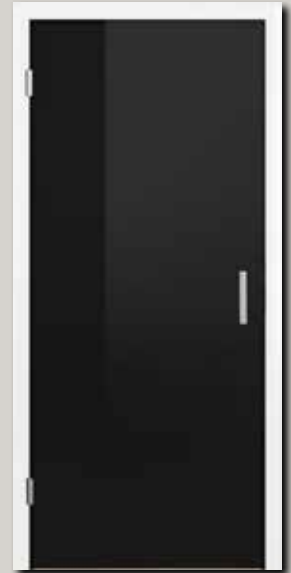

Black

Laminated safety glass, coloured inside film



Lines

Single-pane safety glass, laser technique, with matt stripes



Lito

Single-pane safety glass, laser technique, with matt text



White

Laminated safety glass, coloured inside film



Clear bronze
Single-pane safety glass,
tinted



Clear grey
Single-pane safety glass,
tinted



Dark grey
Single-pane safety glass,
tinted

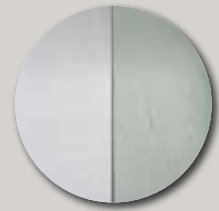

Glass type clear

With this type of glass, the glass door creates a subtle, interesting contrast. The iron oxide in the glass produces a slight "green shimmer".



Glass type Clear White

Glass doors with the Clear White glass type appear in radiant white.



Master-Carré
Single-pane safety glass,
Master-Carré



Satinato
Single-pane safety glass,
Satinato

Satinato look
Laminated safety glass,
matt inside film



Mirastar
Single-pane safety glass,
mirrored and translucent
look on both sides



Clear
Single-pane safety glass

Clear
Laminated safety glass,
clear inside film



Intelligent functions for more security and convenience

Your apartment entrance door can be equipped with many additional functions at Hörmann: Acoustic insulation, fire and smoke protection as well as additional security features such as a spyhole or an automatic door opener can be selected for many styles.

You can increase your everyday living comfort with innovative solutions such as the SmartKey radio door lock operator. You can open your door easily at the push of a button with your handheld transmitter, radio internal push button or directly via the sensor field on the SmartKey.

The door operator PortaMatic is recommended for everyone who is physically disabled or would simply like more convenience. Automatically closing and opening the doors via a hand transmitter or button means improving your quality of life – thanks to Hörmann.



Hörmann apartment entrance doors and fire-rated doors offer more:

More functions than conventional doors. Equip your new Hörmann door to meet your individual needs with important additional functions such as fire protection, acoustic insulation or other security features. In addition, Hörmann supplies wet and damp room doors, jack knife and double-action doors as well as hatches.



Climatic class 3

Doors in this class feature a special door leaf construction, which balances the temperature and moisture differences between rooms with different uses, such as between an unheated cellar and a warm hallway. The effect: energy savings and protection against door warpage.



Acoustic insulation

Acoustic-rated doors are in demand in places where it can be very loud in apartments or offices. The connection between the door and frame is crucial. It is an essential component for guaranteeing the required acoustic insulation.

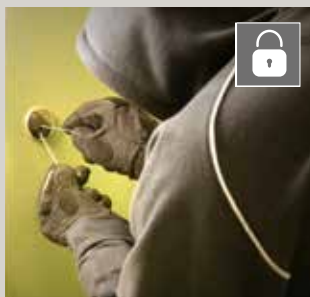

Security







Suitable special functions can significantly reduce the risk of break-ins. Hörmann recommends resistance class RC 2 or, even better, RC 3 for apartment entrance doors.



Fire protection

Fire protection can save lives! A suitably equipped door can protect against penetrating flames (for at least 30 or 90 minutes), but also prevent the penetration of dangerous combustion gases. Fire and smoke-rated elements are only available as a complete package which includes the frame and all fittings.

Climate and apartment entrance doors

	WET system 1*	WET system 2	WET system 3
Door thickness approx.	40 mm	46 mm	52 mm
Max. dimensions	2110 × 985 mm	2235 × 1110 mm	2485 × 1235 mm**
Linkage door closer	○	○	○
Side rail door closer	○	○	○
VarioFix frame	○	○	○
 Climatic class 3	●	●	●
 Acoustic rating category 1	●		
 Acoustic rating category 2		●	
 Acoustic rating category 3		●	●
 RC 2 security equipment		○	
 RC 3 security equipment			●











* Not possible for: Groove lacquer, Steel Concepto / lacquer, Plain Duradecor / lacquer

** with RC 3: 2235 × 1110 mm

● = Standard equipment

○ = Optional equipment

Fire-rated doors / smoke tight doors

	Smoke-tight door*	T30 / RS fire-rated door**	T90 / RS fire-rated door***
Door thickness approx.	46 mm	50 mm	70 mm
Max. dimensions	2235 × 1110 mm	2235 × 1235 mm	2485 × 1235 mm
Linkage door closer	○	●	●
Side rail door closer	●	○	○
 T30 fire-retarding		●	
 T90 fire-proof			●
 Smoke protection	●	○	○
 Climatic class 2		●	●
 Climatic class 3	○	○	○
 Acoustic rating category 1	○	○	○
 Acoustic rating category 2	●	○	○
 Acoustic rating category 3	○	○	○
 RC 2 security equipment	○	○	○
 RC 3 security equipment			○

* On request for: Concepto, Stripe, Groove lacquer, Steel Concepto / lacquer, Plain Duradecor / lacquer

** Not possible for: Stripe, Steel Concepto

*** Not possible for: Concepto, Steel Concepto / lacquer, Stripe, Groove lacquer, Plain Duradecor / lacquer

● = Standard equipment

○ = Optional equipment



Spyhole

With an optional spyhole, you can see who is standing in front of your door at any time without having to open it.



Electric strike

With the optional electric strike catch, you can conveniently open your door via a switch inside the home.



Lock equipment

Optionally as a self-locking automatic lock or motor lock

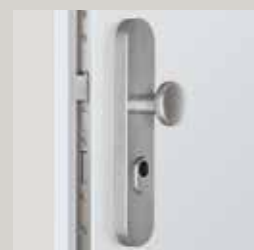

Protective fitting

Optionally as long escutcheon / rose escutcheon ES 1 or long escutcheon / long escutcheon ES 2



Linkage door closer

As standard or optionally for single-leaf doors (depending on design)



Side rail door closer

As standard or optionally for single-leaf and double-leaf doors (depending on design)



Fire protection lever

(Profile cylinder not included in the scope of delivery) As standard in black plastic, or optionally as a stainless steel lever handle.

Radio door lock operator SmartKey

Easily open your door lock at a press of a button with your hand transmitter, radio internal push button or directly via the sensor field on the SmartKey. No need to set down your groceries in order to open your entrance and apartment door. Even with a walker, wheelchair or pram, it is much easier to enter your house or apartment, because you can open the door from a distance. Locking takes place either by pressing a button or automatically after a specified period of time. This securely locks your door and provides protection against break-ins.



The inexpensive radio door lock operator SmartKey is available in white or silver, incl. hand transmitter HSE 4 SK BS with labelled buttons.



High level of operating comfort

- Locking or unlocking the door
- Opening the door (the door latch is retracted for a specified period of time and the door can be easily pushed open) **1**
- Operation via hand transmitter, radio internal push button or BiSecur app **2**
- Automatic comfort locking, either after 30, 60 or 120 s or with a delay after pressing a button **3**
- Manual opening and closing possible at any time, in case of emergency* (from the outside using an ordinary key, from the inside using a hand wheel)

Secure control

- Acoustic / visual feedback on the operator, if the door lock was locked / unlocked or opened
- Enquiry on the optional hand transmitter HS 5 BS or radio internal push button FIT 5 to determine whether the door is locked or unlocked – you no longer have to go to the door in the evening to check whether it is locked. **4**
- BiSecur radio system with extremely secure encryption protocol
- Idle mode with deactivated radio



Door lock is locked



Door lock is unlocked

Ideal for retrofitting

- Flexible fitting by clamping, gluing or screwing on the interior of the door
- No damage to the door or frame (ideal for rental apartments)
- Simply attach to the inserted key**
- Wireless installation thanks to battery operation (lifecycle approx. 1 year*** for 8 cycles per day)



* Cylinder with emergency and hazard function required
 ** Cylinder projection of 7 – 12 mm necessary on the inside, the key head must be shortened to a length of 4 – 7 mm
 *** Depends on the ease of movement of the door or lock as well as the batteries used!

Opening and closing doors effortlessly

With the Hörmann door operator PortaMatic, you can open and close your residential internal doors and steel doors automatically via hand transmitter or button. Whether you are physically disabled or would simply like more convenience – this technology will make your everyday life easier. The door operator PortaMatic features not only an array of functions and settings, but also minimal power consumption. In addition, the PortaMatic is up to 25 % cheaper than similar door operators and can be subsidised up to 100 % by your nursing care insurance.

Find out more about support options at <https://www.hormann.co.uk/private-building-owners-and-modernisers/operators/internal-door-operators>



For additional information, consult the "Door operator PortaMatic" brochure.



The PortaMatic is the only door operator to date to have been tested and approved by the Deutsche Gesellschaft für Gerontotechnik (GGT – German Association for Gerontology Technology). As a result, it fulfils the expectations of customers aged 50+ with respect to convenience, quality and aesthetics.

Senior-friendly residences

Would you like to stay mobile despite physical limitations? The PortaMatic operator for residential internal doors improves your quality of life by helping you move about your home unaided.

Convenient living

You can now carry full trays, heavy crates of beverages or your shopping bags into your rooms unhindered. You will never want to do without this convenience ever again.

Barrier-free working

Barrier-free working is already of great importance and will become even more significant in the future. The door operator PortaMatic can be easily integrated into all non-public areas at your workplace, thus ensuring more convenience.

Hygienic door operation

In office buildings, the risk of infection among employees is especially high on doors leading to the lavatory. In combination with a non-contact switch, the PortaMatic door operator provides reliable protection from germs and bacteria, giving you a sense of security.





The robust steel frame VarioFix

In addition to the standard timber frames, all our residential internal doors are also available with the steel frame VarioFix. It is the ideal solution for apartment entrance doors and internal doors in the home and project sector where high resistance and durability are necessary.

The VarioFix frame harmonises perfectly with other timber frames due to the frame face of 55 mm on both sides. This way, you can also use doors with different frames in one room or house.

For the steel frame VarioFix, wall tolerances of up to 20 mm are no problem.

The adjustable decorative rebate easily compensates for different wall thicknesses during renovations and new construction projects.

The VarioFix frame is available in Traffic white RAL 9016 to match our door leaves in Duradecor White lacquer, White lacquer and RAL to choose.



The frame face of 55 mm on both sides of the VarioFix frame (shown on the left) harmonises very well with timber frames (shown on the right).



The VarioFix frame is especially robust and can withstand "accidents" with toy cars or run-ins with the vacuum cleaner.



The VarioFix frame is also suited for apartment entrance doors with RC 2 security equipment and acoustic insulation.



VarioFix: the steel frame with many benefits

Especially resistant to damage **1**

The robust VarioFix frame can also withstand a toy car or vacuum cleaner smashing into it. Edges on timber frames can be damaged or even chipped in such cases.



Resistant to cleaning water **2**

The VarioFix frame is the perfect solution for rooms with tiled floors. Thanks to the high-quality galvanization, even cleaning water cannot damage the frame. With timber frames there is a danger that the bottom frame edge will swell or that it must be sealed with an unattractive silicone joint.



Invisible mitre cut **3**

For the powder-coated steel frame VarioFix, the corner joints feature high-quality welding and a flush polish, meaning there are no visible mitre cuts in the frame corners, in contrast to timber frames.

Uniform gap dimension for flush-closing doors **4**

Due to the stable steel construction, the VarioFix frame cannot warp after fitting. This guarantees a uniform gap dimension for flush-closing doors and ensures a harmonious and elegant door appearance.



Our space-saving marvels: sliding doors

Sliding doors open up new possibilities for ideal use of your living space. Hörmann offers single-leaf and double-leaf sliding door solutions for every living situation. All door styles in the BaseLine, DesignLine and GlassLine ranges are available as sliding doors.



Sliding door system in the frame

When fitted in front of the wall, the door leaf slides on two tracks mounted in the sliding door box. When fitted running within the wall, the guide rails are fitted in an on-site door pocket in the wall. This eliminates the sliding door box. The wall opening is concealed by the frame.



With the brush on the door leaf (figure on left) and the optional inlet seal in the frame (figure on right), Hörmann sliding doors with frame type C running in front of the wall offer optimal protection against odours, noise and draughts – for even more comfort in your own home.



Sliding door system Slide Compact

With this system, the door leaves slide in a guide rail profile. The profile in a stainless steel colour can be fitted both in front of the wall and to the ceiling. For a door leaf weight of up to 60 kg, the Slide Compact system is equipped with a SafeClose in order to gently close the door leaves.



Sliding door system Rotan

In this trendy industrial-style sliding door system, the doors are mounted on support brackets that slide over rollers on a track rail. The stainless steel rail is fitted to the wall.



Sliding door system Slide Compact with additional vertical stop for single-leaf doors, running in front of the wall



The profile is also available in matt black (left fig.) or white (right fig.).



Cool chic, elegant function: With the sliding door system Rotan, the support brackets slide over rollers on the track rail.

Glazing cut-outs

With our selection of glazing cut-outs, you can take your favourite style and make the personalised door of your dreams. Glazing cut-outs are available in the glazing of your choice.



Side elements and transom lights

Side elements and transom lights flood your living spaces with light for that special flair. While side elements visually enhance the door sets, transom lights emphasise the room height. Top parts underscore the ceiling-high appearance of the door set.



Glazing cut-outs

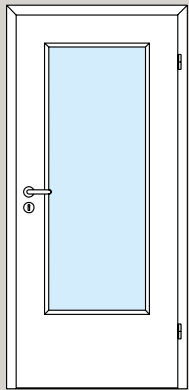

DIN

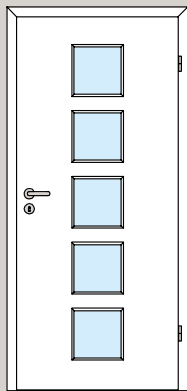

LA 5

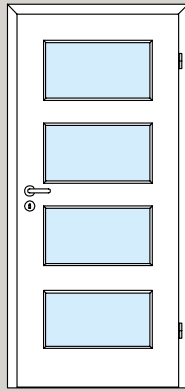

LA 9

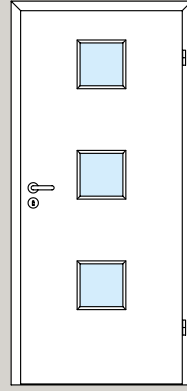

LA 10

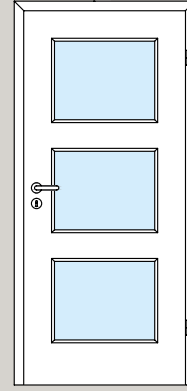

LA 11

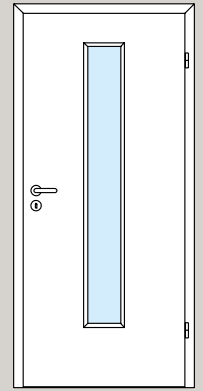

LA24 centre

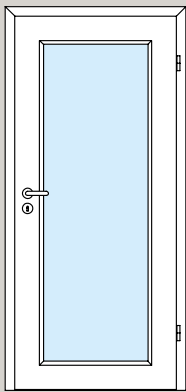

LA 27

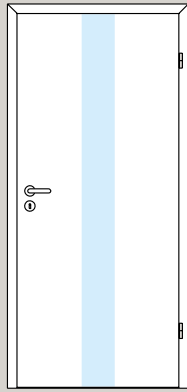

LA Pure

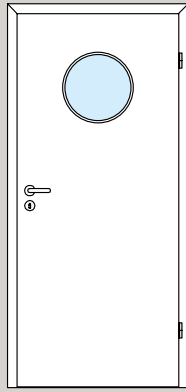

Round glazing

All door styles in the DesignLine Georgia, Vermont and Carolina ranges are available with glazing in the upper panel sections.

Side elements (intel-high)

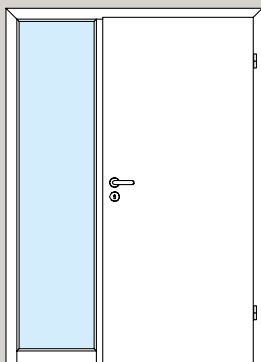

Single-leaf, 1 side element

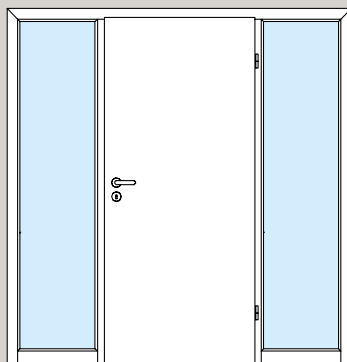

Single-leaf, 2 side elements

Transom lights (ceiling-high)

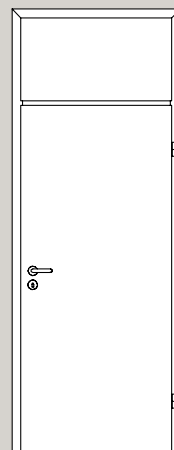

Single-leaf, 1 top part,
alternatively also with
transom light

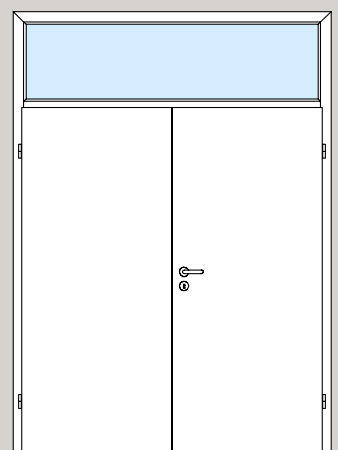

Double-leaf, 1 transom light

Individual wishes within reach

We are only satisfied when you have found your dream door, where every detail is right. The range of **lever handle sets for timber doors** can be found in our programme optionally as a flush-fitting **Planar version**, for the most elegant view. For design fans, we recommend lever handles and fittings **in the black.edition**. Special fittings for **glass doors** and **sliding doors** round off the extensive range.



Dark colours with black accents are becoming increasingly popular. Hörmann now offers a range of fittings in the new black.edition for timber and glass doors.

Lever handle sets for timber doors



Ala round rose escutcheon, matt stainless steel



Apart round rose escutcheon, matt stainless steel



Arundo round rose escutcheon, matt stainless steel



Basica 2 round rose escutcheon, matt stainless steel



Basica 3 round rose escutcheon, matt stainless steel



Contra round rose escutcheon, matt stainless steel



Dee round rose escutcheon, matt stainless steel

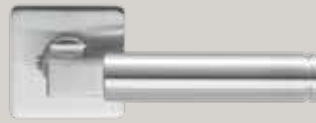

Dee angular rose escutcheon, matt stainless steel



Graphica angular rose escutcheon, polished stainless steel



Graphica angular flat rose escutcheon, matt stainless steel



Indra round rose escutcheon, matt polished stainless steel



Indra round flat rose escutcheon, matt stainless steel



Karee angular rose escutcheon, matt stainless steel

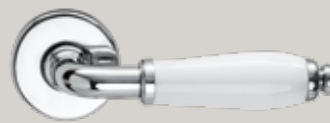

Lilet round rose escutcheon, polished stainless steel, white porcelain handle



Linea round rose escutcheon, matt stainless steel



Optionally also available for fire-rated doors

LEVER HANDLES AND FITTINGS

Lever handle sets for timber doors



Linea round flat rose escutcheon, matt stainless steel



Linea round flat rose escutcheon, polished stainless steel



Linea black.edition, round rose escutcheon, matt black



Linea angular flat rose escutcheon, matt stainless steel



Luba round rose escutcheon, matt stainless steel



Linea black.edition, flat rose escutcheon, matt black



Quadrige angular rose escutcheon, matt stainless steel



Selecta round rose escutcheon, matt polished stainless steel



Karee black.edition, angular rose escutcheon, matt black



Senso round rose escutcheon, matt stainless steel



Tento round rose escutcheon, matt stainless steel



Karee black.edition, flat rose escutcheon, matt black



Vallis round rose escutcheon, matt stainless steel



Vento round rose escutcheon, matt stainless steel

Fittings for glass doors



Fitting set Aronda Combi, matt stainless steel, polished stainless steel or EV 1



Fitting set Purista Combi, matt stainless steel, polished stainless steel or EV 1



Fitting set Conica Combi, matt stainless steel or EV 1



Fitting set Mina Combi, matt stainless steel



Fitting set Purista Combi, black.edition, matt black



Apart, matt stainless steel or polished / matt stainless steel



Basica 3, matt stainless steel or EV 1



Belis, matt stainless steel



Dee, matt stainless steel, polished stainless steel or EV 1

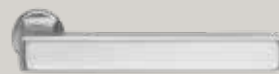

Graphica, matt stainless steel or polished stainless steel



Nala, matt stainless steel or polished stainless steel



Quadriga matt stainless steel



Linea, matt stainless steel, polished stainless steel or EV 1



Linea, black.edition, matt black



Karee, black.edition, matt black

Flush-fitting Planar track application



For an especially elegant door appearance, lever handles are optionally available in a flush-fitting Planar variant, as well as without drilled keyhole.

Elegant glass door track application



This innovation for glass doors can be used with timber and with steel frames. The reduced view of the fitting profile makes a very elegant impression. Practical: lever actuation is not necessary to open the door.

LEVER HANDLES AND FITTINGS

Recessed lever handles for sliding doors

Handle bars for sliding doors



Recessed lever handle 6402 for timber doors, round, matt stainless steel or black.edition

Design recessed lever handle 3649 for timber doors, oval, matt stainless steel



Design recessed lever handle 3648 for timber doors, angular, matt stainless steel



Recessed lever handle FSB 4212, oval, matt stainless steel or aluminium



Recessed lever handle FSB 4251, angular, fastenings for pushing in, matt stainless steel



Recessed lever handle FSB 4250, fastenings for pushing in, matt stainless steel (for timber doors)



Recessed lever handle FSB 4252, round, fastenings for pushing in, matt stainless steel



Recessed lever handle FSB 4253, angular, fastenings for pushing in, matt stainless steel



Recessed lever handle Norma 3657, oval, matt stainless steel



Recessed lever handle Rondell 3659, round, matt nickel



Handle bar pair Basic, round, matt stainless steel



Handle bar pair U-grip, round, matt stainless steel



Handle bar combination Combi, flat handle



Pair of handle bars, Basic, angular, matt stainless steel



Handle bar pair U-grip, angular, matt stainless steel



Handle plate, black.edition Similar to stainless steel (shown below)



For sliding doors running within the wall, you can use a trip handle to release a door leaf completely concealed in the wall and close the door at the push of a button.

The handle plate can be used to fully open the sliding door running in front of the wall.

Fittings for flush-closing door leaves



Deadlock, Class I, lock cover in nickel silver (as standard)



Magnetic latch lock to gently and quietly close the door (optional)



3-part guide roller hinge V 7888 WF, 3-way adjustable (optional, only for timber frame)



Concealed 3-way adjustable hinge DX 61 (optional)



Concealed Euro hinge (optional)

Fittings for rebated door leaves



Deadlock, Class I, lock cover in nickel silver (as standard)



2-part hinge V 3420 WF (standard)

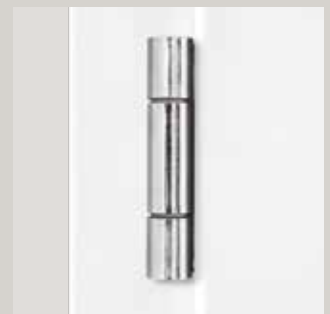

3-way adjustable hinge VX 160-18 (optional)



3-part hinge V 4426 WF (optional)



Concealed hinge Pivota FX 2 60, 3-way adjustable (optional)

High-quality surfaces, a variety of colours, and natural decors you will enjoy day after day



Duradecor smooth

- 48 % more impact-resistant than the average of the tested CPL surfaces from other manufacturers
- Hygienic and easy-to-clean
- Strong anti-static and colour-fast properties
- Resistant to heat and abrasion
- Stands up to normal household fluids, pastes, etc.

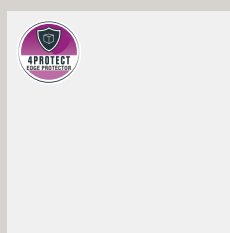

White lacquer
RAL 9016

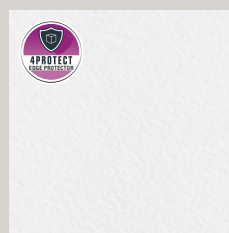

White Parchment

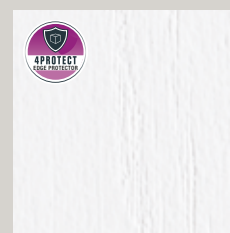

White Ash



Light grey
RAL 7035



Light grey
Parchment



4Protect edge protector

- High impact resistance
- High wear resistance
- High scratch resistance
- Perfect joint-free look, i.e. no visible joints, to satisfy the highest aesthetic demands



Canadian Maple

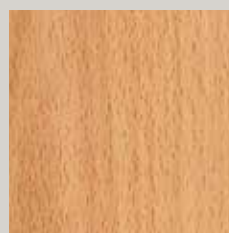

French Beech

Please note:

The colours and decors shown are subject to the limitations of the printing process and cannot be regarded as binding. All colours based on RAL.



Duradecor texture

- Characteristic timber texture with embossed wood grain
- 48 % more impact-resistant than the average of the tested CPL surfaces from other manufacturers
- Hygienic and easy-to-clean
- Strong anti-static and colour-fast properties
- Resistant to heat and abrasion
- Stands up to normal household fluids, pastes, etc.



Grey Oak



Grey Oak
(Transverse)

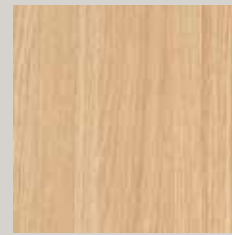

White Oak



White Oak
(Transverse)

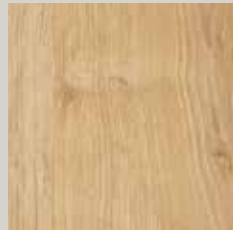

Wild Oak

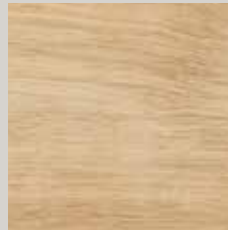

Wild Oak
(Transverse)

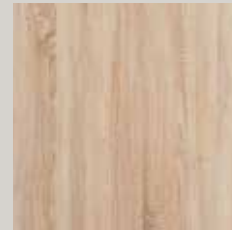

Raw Oak



Raw Oak
(Transverse)

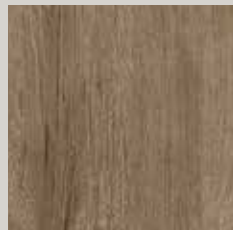

Dark Oak

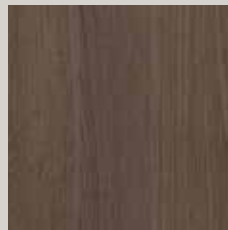

Spanish Oak

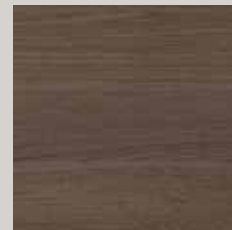

Spanish Oak
(Transverse)



Walnut



Italian Acacia



Brushed Salted Oak



Brushed Pine

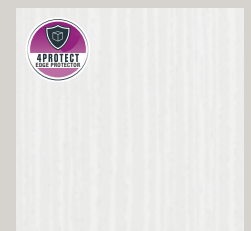

Brushed White



4Protect edge protector

- High impact resistance
- High wear resistance
- High scratch resistance
- Perfect joint-free look, i.e. no visible joints, to satisfy the highest aesthetic demands

Ultra matt

- Velvety feel
- Duradecor surface finish with maximum impact resistance
- Anti-fingerprint to minimise fingerprints and soiling
- Can be coloured with chalk

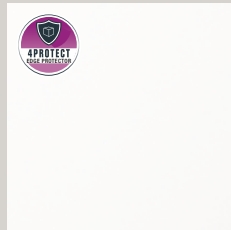

Ultra matt
Traffic white



Ultra matt
Light grey

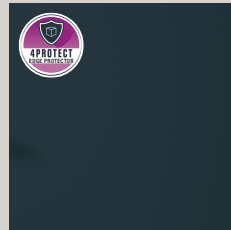

Ultra matt
Anthracite grey



Ultra matt
Taupe

Gloss

- High-gloss
- Extremely smooth surface finish
- Highly durable

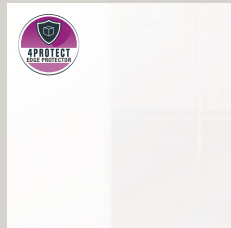

Gloss
Traffic white



Gloss
Light grey

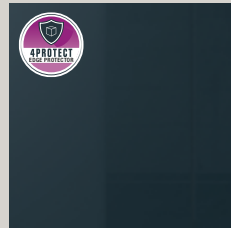

Gloss
Anthracite grey

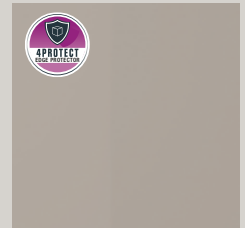

Gloss
Taupe

Slate

- With raised texture
- Contrast of matt and gloss
- Highly durable

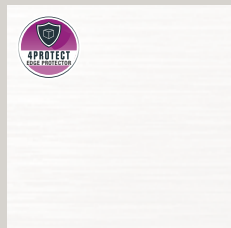

Slate
Traffic white



Slate
Light grey



Slate
Anthracite grey

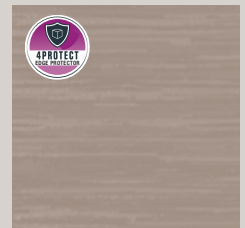

Slate
Taupe

Linen

- Fine texture with natural appearance
- Duradecor surface finish with maximum impact resistance

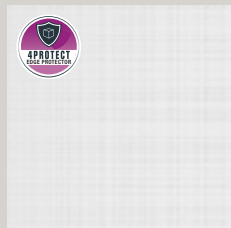

Linen
Traffic white

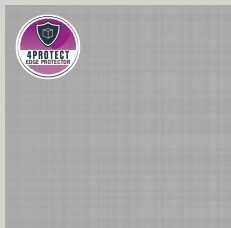

Linen
Light grey

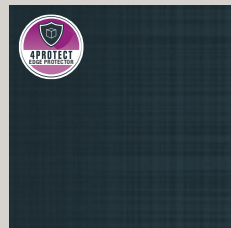

Linen
Anthracite grey

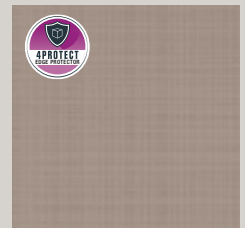

Linen
Taupe



Lacquer

- Smooth surface
- Rich, vibrant colour
- Paint coating on a white Duradecor base plate
- On request in RAL to choose

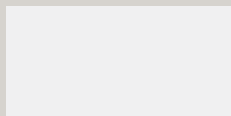

Traffic white
RAL 9016

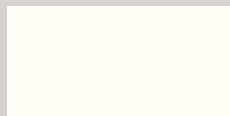

Pure white
RAL 9010

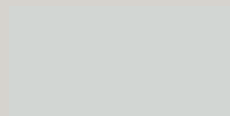

Light grey
RAL 7035

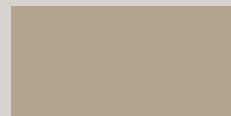

Taupe
RAL 7048

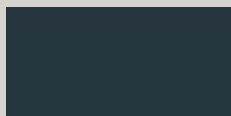

Anthracite grey
RAL 7016

Real wood veneer

- Made of high-quality real timber
- Environmentally friendly protective paint for durable surface protection
- Natural wood grain
- Long-lasting quality



Maple

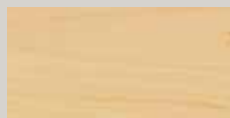

Maple horizontal



Beech



Beech horizontal



Ash



Limba



Paintable Limba



Mountain Oak



American Oak



American Oak horizontal



Knotted Oak

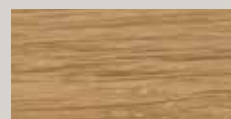

Knotted Oak horizontal



Matt lacquer Alpine Oak



Oiled Oak in stressed timber



American Walnut

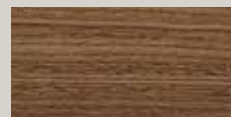

American Walnut horizontal



Stained Oak



Macore



Mahogany

Please note:

The colours and decors shown are subject to the limitations of the printing process and cannot be regarded as binding. All colours based on RAL.

Premium carpenter quality for high demands

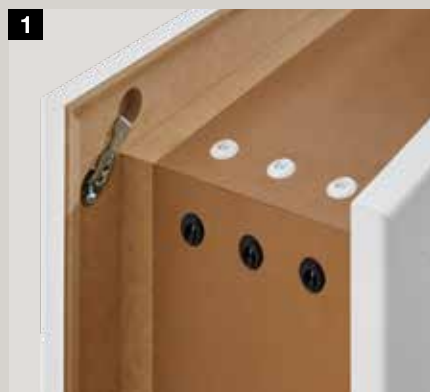

1 Attractive appearance with precision fit and installation-friendly corner joints

Jamb lining

- Screwed corner joints with jamb lining connection
- Easily readjustable
- Strong friction locking

Cladding

- Solid-metal screw connectors
- Excellent friction locking
- Direct pressure distribution on the connection surfaces
- No visible drilled holes in the cladding

2 High form stability thanks to the robust frame construction

- Jamb lining 25 mm thick
- Jamb lining with Duradecor surface finish
- Melamine-coated backing
- Claddings made of MDF

3 Permanently quiet closing thanks to a high-quality seal

- Two-chamber system
- Clean contact to the door leaf
- Good absorbing properties

4 Robust standard lock plate for added security

- Movable backfill
- Secured with six screws
- Double-turn locking
- Conversion sets available

1

2

3

4

7

8





5 Hybrid hinge pocket prevents lowering of the door

- Carrying capacity 80 kg
- Reinforced metal plastic mount
- Four-point screw connection in jamb lining
- Guiding sleeves extending to front edge of cladding
- for timber and glass doors



6 High stability thanks to door leaf with frame reinforcement

- Residential internal doors with 80 mm frame reinforcement
- On hinge side and lock side



7 Attractive round edge due to high-quality base materials



8 Robust angular edges thanks to 4Protect edge protector

- High impact resistance
- High wear resistance
- High scratch resistance
- Perfect joint-free look, meaning that unlike conventional doors, no visible joints **9** disturb the high-quality appearance of the door
- As standard for rebated doors with angular edges or flush-closing doors with Duradecor White lacquer, Light grey and Anthracite surface finishes



10 Modern colour

- In standard colour White lacquer RAL 9016























Strong Duradecor surface finish

- Extremely resistant to impact and scratching
- Colour-fast, heat-resistant



OVERVIEW TABLE

Door styles

	BaseLine	DesignLine Concepto	DesignLine Stripe	DesignLine Groove	DesignLine Steel	DesignLine Plain	DesignLine Rail	DesignLine Pure	ClassicLine Georgia	ClassicLine Carolina	ClassicLine Montana	ClassicLine Kontura	ClassicLine Virginia
Surface finishes													
Duradecor													
Rebated angular		●	-	○	-	●	●	●	●	●	-	-	-
Rebated round		●	-	-	-	●	●	●	●	●	-	-	●
Flush angular		●	-	○	-	●	●	●	●	●	-	-	-
Duradecor texture													
Rebated angular		●	-	-	-	●	●	●	●	○	-	-	-
Rebated round		●	-	-	-	●	●	●	●	○	-	-	-
Flush angular		●	-	-	-	●	●	●	●	○	-	-	-
Real wood veneer													
Rebated angular		●	-	-	-	-	-	●	-	○	-	-	-
Rebated round		○	-	-	-	-	-	○	-	○	-	-	-
Flush angular		●	-	-	-	-	-	●	-	○	-	-	-
Lacquer													
Rebated angular		●	-	-	●	●	●	●	●	●	-	-	-
Rebated round		●	-	-	●	●	●	●	●	○	○	○	-
Flush angular		●	-	-	●	●	●	●	●	●	-	-	-
Ultra matt													
Rebated angular		-	●	-	-	●	-	-	-	-	-	-	-
Rebated round		-	●	-	-	●	-	-	-	-	-	-	-
Flush angular		-	●	-	-	●	-	-	-	-	-	-	-
Gloss													
Rebated angular		-	●	-	-	-	-	-	-	-	-	-	-
Flush angular		-	●	-	-	-	-	-	-	-	-	-	-
Slate													
Rebated angular		-	●	-	-	-	-	-	-	-	-	-	-
Flush angular		-	●	-	-	-	-	-	-	-	-	-	-
Linen													
Rebated angular		-	●	-	-	-	-	-	-	-	-	-	-
Rebated round		-	●	-	-	●	-	-	-	-	-	-	-
Flush angular		-	●	-	-	-	-	-	-	-	-	-	-

● = Available for all decors / colours

○ = Not available for all decors / colours

Door inlay

Honeycomb insert	Tubular chipboard spacers	Tubular chipboard plate	Solid chipboard
●	-	●	●
-	●	●	●
-	-	●	●
●	-	●	●
-	●	●	●
-	-	●	●
-	●	●	●
-	○	○	○
-	●	●	●
●	-	●	●
-	●	●	●
-	●	●	●
-	-	●	●
-	-	●	●
-	-	●	●
-	-	●	●
-	-	●	●
-	-	●	●
-	-	●	●
-	-	●	●
-	-	●	●
-	-	●	●
-	-	●	●
-	-	●	●
-	-	●	●
-	-	●	●
-	-	●	●



Honeycomb insert
 The honeycomb insert retains its shape and has an excellent price-performance ratio.



Tubular chipboard spacers
 The door inlay consists of individual spacers that are arranged in the best possible layout. This means the door leaf is especially sturdy and suitable for heavy wear.



Tubular chipboard plate
 The solid plate with horizontal tubes gives door leaves high surface stability. These high-quality residential internal doors are suitable for even heavier wear.



Solid chipboard
 The high-quality solid chipboard door leaves have the highest leaf rigidity and are suitable for particularly heavy wear. Doors with glazing cut-outs are available with solid chipboard as standard.

Frame types



Profile frame with rounded edges



Profile frame with angular edges (only for lacquer surface)



Profile frame with profile for ClassicLine Georgia and Carolina



Block frame

Door leaf

- Approx. 40 mm thick
- Frame construction made of solid timber / timber material with additional frame reinforcement, can be shortened by 25 mm at bottom
- For double-leaf doors: with counter rebate*
- Climatic class I, duty category N to S (depending on version)
- Ready-to-hang acc. to DIN 18101
- Suited for timber profile frames or standard frames made of steel

Frame

- Rebate cladding 16 × 60 mm, mitred and firmly glued to the jamb lining. 16 × 80 mm on request
- Jamb lining made of 25 mm chipboard, rebate cladding and decorative edge made of 12 MDF boards
- Decorative edge 16 × 60 mm, optionally 16 × 80 mm
- Adjustable for wall thickness - 5 mm / + 15 mm
- Sound-absorbing seal inserted at the factory, mitred

Vertical view

Rebated

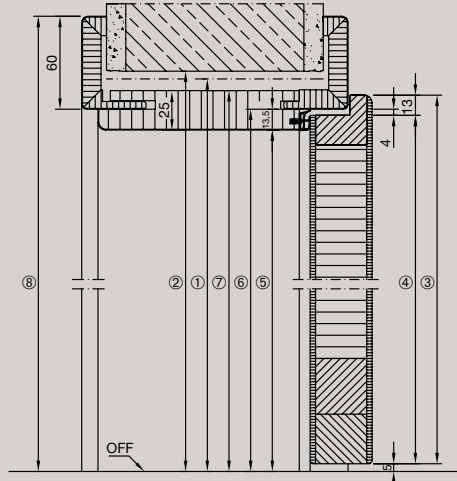

Flush

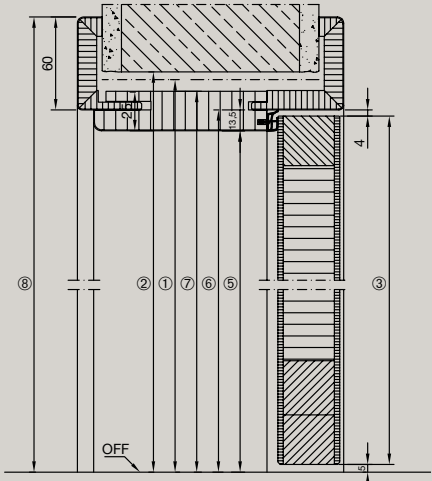

		1875	2000	2125	2250	
1	Nominal size height	1875	2000	2125	2250	
2	Wall opening	1880	2005	2130	2255	
3	Overall door leaf dimension	Rebated	1860	1985	2110	2235
		Flush	1847	1972	2097	2222
4	Leaf rebate dimension	1847	1972	2097	2222	
5	Clear passage dimension	1843	1968	2093	2218	
6	Frame hold dimension	1856	1981	2106	2231	
7	Overall lining dimension	1868	1993	2118	2243	
8	Overall frame dimension for 60 mm cladding (for 80 mm cladding + 20 mm)	1916	2041	2166	2291	

Frame types

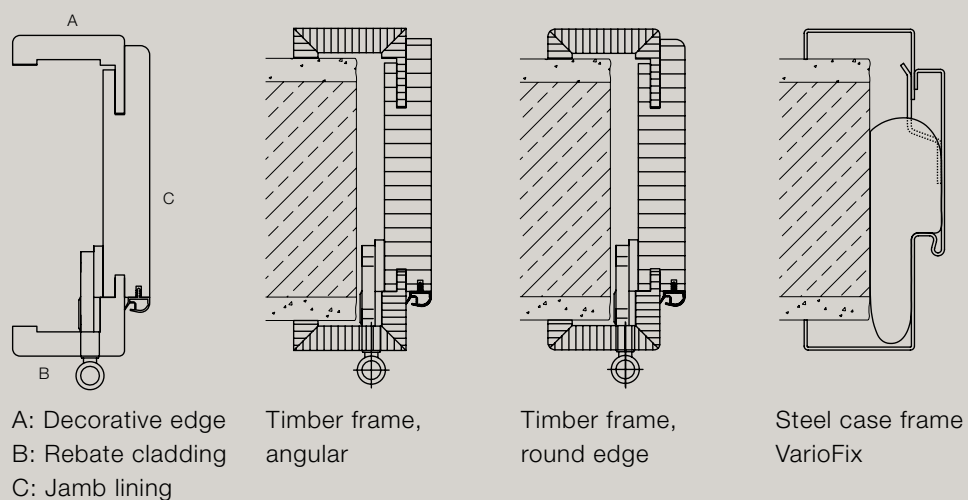

A: Decorative edge
B: Rebate cladding
C: Jamb lining

Timber frame, angular

Timber frame, round edge

Steel case frame VarioFix

Horizontal view – single-leaf

Rebated

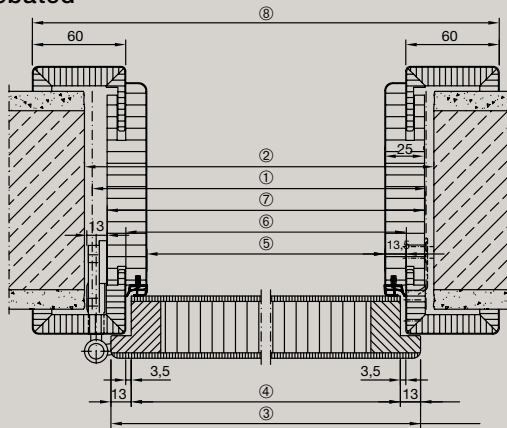

Flush

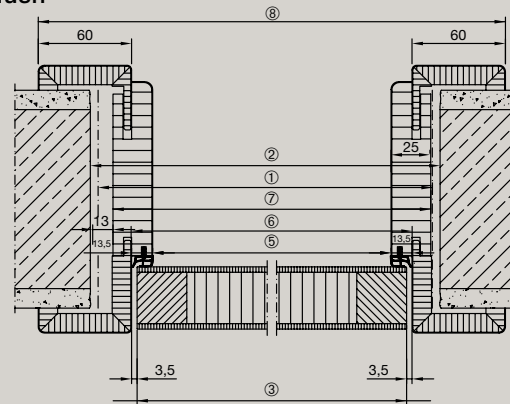

		625	750	875	1000	1125	1250
1 Nominal size width		625	750	875	1000	1125	1250
2 Wall opening		635	760	885	1010	1135	1260
3 Overall door leaf dimension	Rebated	610	735	860	985	1110	1235
	Flush	584	709	834	959	1084	1209
4 Leaf rebate dimension		584	709	834	959	1084	1209
5 Clear passage dimension		564	689	814	939	1064	1189
6 Frame hold dimension		591	716	841	966	1091	1216
7 Overall lining dimension		614	739	864	989	1114	1239
8 Overall frame dimension		711	836	961	1086	1211	1336

Horizontal view – double-leaf

Rebated

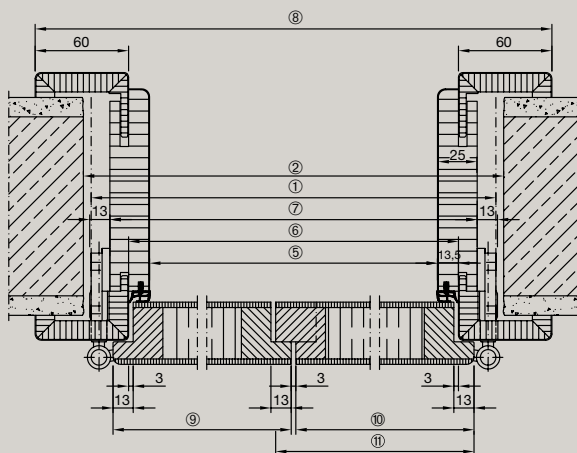

Flush

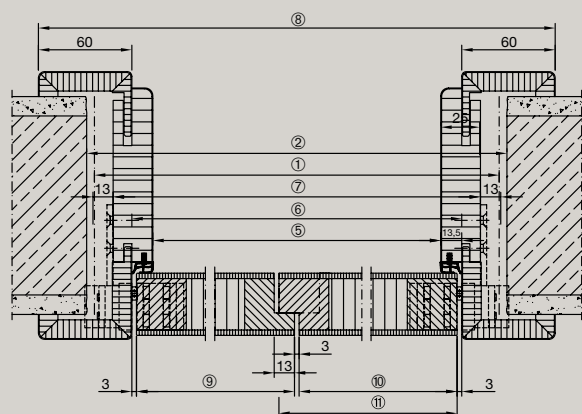

		1250	1375	1500	1750	1875	2000	2250	2500
1 Nominal size width		1250	1375	1500	1750	1875	2000	2250	2500
2 Wall opening		1260	1385	1510	1760	1885	2010	2260	2510
5 Clear passage dimension		1176	1301	1426	1676	1801	1926	2176	2426
6 Frame hold dimension		1203	1328	1453	1703	1828	1953	2203	2453
7 Overall lining dimension		1226	1351	1476	1726	1851	1976	2226	2476
8 Overall frame dimension		1323	1448	1573	1823	1948	2073	2323	2573
9 Overall door leaf dimension	Rebated	610	735	735	860	985	985	1110	1235
	Flush	597	722	722	847	972	972	1097	1222
10 Overall door leaf dimension	Rebated	610	610	735	860	860	985	1110	1235
	Flush	597	597	722	847	847	972	1097	1222
11 Overall door leaf dimension	Rebated	623	623	748	873	873	998	1123	1248
	Flush	610	610	735	860	860	985	1110	1235

* Only for Carolina door styles

All dimensions in mm



HORMANN

Experience Hörmann quality in new construction and modernisation

Hörmann provides an excellent basis for comprehensive planning. Carefully matched solutions offer you the very best in perfectly designed products for every area.

- **Garage doors**

Optimally match your personal architectural style: up-and-over or sectional doors made of steel or timber.

- **Gate and door operators**

Enjoy extra convenience and break-in-resistant security with Hörmann operators for garage doors and entrance gates. You can profit from the convenience of Hörmann door operators in your residential space as well.

- **Entrance doors**

Our comprehensive entrance door ranges include models that fit almost every need and requirement.

- **Residential internal doors**

Our high-quality timber and glass doors give your home an extra level of comfort and integrate harmoniously into the overall appearance of your home.

- **Steel doors**

Sturdy doors for your entire home, from basement to roof.

- **Frames**

Choose from our comprehensive range of products for new construction, expansion and modernisation.



Garage doors and entrance gate operators



Entrance doors



Steel doors

Hörmann: Quality without Compromise



Hörmann KG Amshausen, Germany



Hörmann KG Antriebstechnik, Germany



Hörmann KG Brandis, Germany



Hörmann KG Brockhagen, Germany



Hörmann KG Dissen, Germany



Hörmann KG Eckelhausen, Germany



Hörmann KG Freisen, Germany



Hörmann KG Ichttershausen, Germany



Hörmann KG Werne, Germany



Hörmann Alkmaar B.V., Netherlands



Hörmann Legnica Sp. z o.o., Poland



Hörmann Beijing, China



Hörmann Tianjin, China



Hörmann LLC, Montgomery IL, USA



Hörmann Flexon LLC, Burgettstown PA, USA



Shakti Hörmann Pvt. Ltd., India

Hörmann is the only manufacturer worldwide that offers you a complete range of all major building products from one source. We manufacture in highly-specialised factories using the latest production technologies. The close-meshed network of sales and service companies throughout Europe, and activities in the USA and Asia, make Hörmann your strong partner for first-class building products, offering “Quality without Compromise”.

GARAGE DOORS
OPERATORS
INDUSTRIAL DOORS
LOADING EQUIPMENT
HINGED DOORS
DOOR FRAMES

HÖRMANN